

# SMOOTH



Uno stile minimale e duttile capace di offrire alla clientela del locale tutto ciò che serve.

Questa è l'opera **Smooth** di ItalProjet; una proposta completa, un nuovo concept, un nuovo modo di pensare il proprio locale, essenziale nei tratti e nel modo di porsi, ma allo stesso tempo, abile nel soddisfare in maniera ottimale l'esigenza di mostrare tutti i prodotti valorizzando il loro lato migliore.

*Minimal and ductile style able to offer the customer everything he needs. This is **Smooth** by Italprojet; a complete offer, a new concept, a fresh way of considering your establishment, an essential line and essential in the way of presenting itself, but at the same time, able to fully satisfy the need to display all products, focusing on their best side.*





GELATO *Gelato*

PASTICCERIA *Pastry*

PRALINERIA *Praline*

CALDO A SECCO *Dry heat*

BAGNO MARIA *Bain marie*





Progettata e realizzata per venire incontro alle necessità di un mercato sempre più esigente **Smooth** racchiude in tre moduli le peculiarità di una struttura attrezzatissima in grado di servire un'ampia clientela. Grazie all'uso di tecnologie avanzatissime, ognuno dei tre settori è perfettamente strutturato in modo da contenere e conservare simultaneamente prodotti che per loro natura richiedono condizioni differenti.

*Designed and realised to satisfy an increasingly demanding market, **Smooth** encloses the peculiarity of a fully equipped structure able to serve a wide range of customers using just three modules. Thanks to the use of advanced technologies, each of the three sectors is perfectly structured in a way to simultaneously contain and preserve products which, owing to their nature, require different conditions.*



## SMOOTH

### GELATO *Gelato*

COLORI PERSONALIZZABILI  
Customizable colors



**GELATO**  
*Gelato cabinet*



**REFRIGERAZIONE VENTILATA**  
*Ventilated refrigeration*



#### CARATTERISTICHE TECNICHE

##### technical specifications

Struttura completamente in INOX AISI304.

Sbrinatorio dell'evaporatore veloce ad inversione di ciclo.

Alzata in vetro.

Unità condensatrice ermetica 230V/50.

Vetrina utilizzabile anche per semifreddi o torte gelato.

Support structure completely in s/s AISI304.

Rapid automatic reverse cycle evaporator defrost.

Glass superstructure.

Hermetic condensing unit 230V / 50Hz.

The display cabinet can also be used

for semifreddo or gelato cakes.

## SMOOTH

### VENTILATA *Smooth ventilated*

COLORI PERSONALIZZABILI  
Customizable colors



**VETRINA PASTICCERIA**  
*Gelato cabinet*



**REFRIGERAZIONE VENTILATA**  
*Ventilated refrigeration*



#### CARATTERISTICHE TECNICHE

##### technical specifications

Struttura completamente in INOX AISI304.

Versioni: con refrigerazione TN ventilata,

con refrigerazione TN statica, calda a bagno maria, calda a secco, neutra.

Comprensiva di alzata in vetro.

U.C. a bordo per la versione refrigerata.

Support structure completely in s/s AISI304.

Versions: ventilated refrigeration TN, Static refrigeration TN,

Bain-marie hot food, Dry heat food, Ambient.

Inclusive of glass superstructure.

Internal condensing unit for refrigerated version.

#### GELATO

Base / Basic

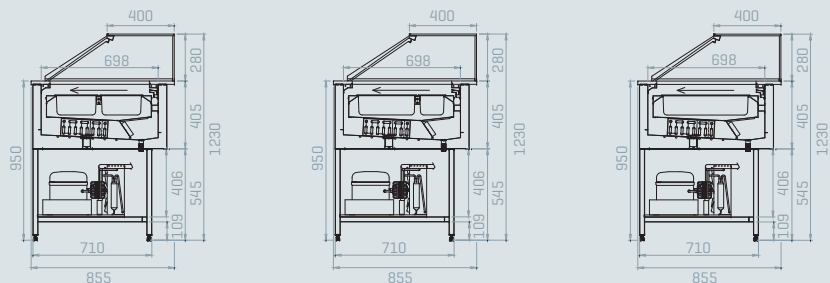

#### VENTILATA

Base / Basic

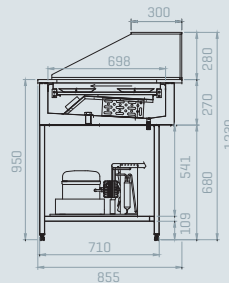

#### VENTILATA CON RISERVA

Base / Basic

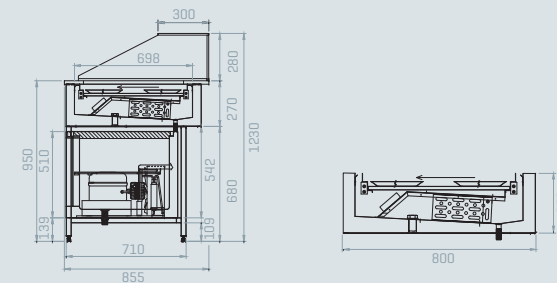

# SMOOTH

CALDA A SECCO *Smooth heat*

COLORI PERSONALIZZABILI  
*Customizable colors*



**CALDO A SECCO**  
*Smooth heat*



## CALDA A SECCO

Base / Basic

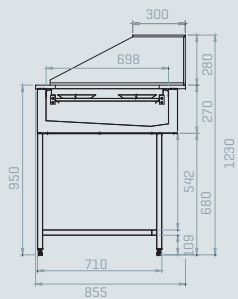

# SMOOTH

BAGNO MARIA *Smooth bain marie*

COLORI PERSONALIZZABILI  
*Customizable colors*



**VETRINA BAGNO MARIA**  
*Bain marie*



## BAGNO MARIA

Base / Basic

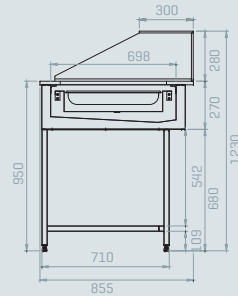

## POZZETTI

Gelato

COLORI PERSONALIZZABILI  
Customizable colors



**REFRIGERAZIONE VENTILATA**  
Ventilated refrigeration



**REFRIGERAZIONE STATICA**  
Static refrigeration



### CARATTERISTICHE TECNICHE

*technical specifications*

Struttura completamente in INOX AISI304.  
Compreso: contenitore per carapine singole, cornice completa di coperchio, U.C. a bordo. Escluso: Carapine e Glicole  
Support structure completely in stainless steel AISI304. Including: single bins holder, complete frame with lid, Internal condensing unit. Excluded: bins and glycol.

Temperatura -8 / -21°C

Tecnologia applicata e una struttura dal design pulito e lineare: i pozzetti della linea Smooth sono il connubio di utilità ed eleganza. Alle garanzie comprovate dall'uso di materiali di altissima qualità si aggiunge la praticità di un termostato che permette di impostare e mantenere con precisione assoluta le temperature più adatte alla conservazione di gelati e granite, valorizzandone sia il gusto che l'aspetto.

Cold store -8 / -21 °C

Applied technology and a clean and linear structure: the Smooth line pozzetti are the combination of utility and elegance. The practicality of a thermostat is added to the proven guarantee of top quality materials, thus allowing to set the most suitable temperatures for preserving ice-creams and grated ice drinks and maintaining them with absolute accuracy, enhancing both flavour and appearance.

Base / Basic

Pannellata / Panelled

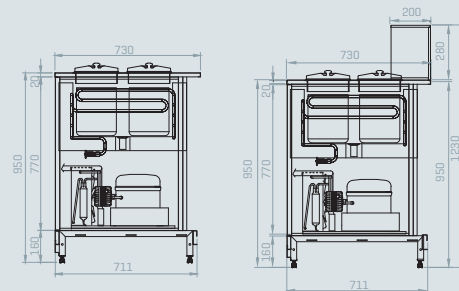

## TOPPING

Topping

COLORI PERSONALIZZABILI  
Customizable colors



**BAGNO MARIA**  
Bain marie



**REFRIGERAZIONE VENTILATA**  
Ventilated refrigeration



### CARATTERISTICHE TECNICHE

*technical specifications*

Struttura completamente in INOX AISI304.  
Versioni: con refrigerazione TN ventilata, con refrigerazione TN statica, calda a bagno maria, calda a secco, neutra.  
U.C. a bordo per la versione refrigerata.

Support structure completely in s/s AISI304.  
Versions: ventilated refrigeration TN, Static refrigeration TN, Bain-marie hot food, Dry heat food, Ambient. Internal condensing unit for refrigerated version.

Cella Frigo +2/+4°C  
Vaschette refrigerate per salse e frutta +2/+4°C  
Vaschette riscaldate per salse calde +40/+60°C  
Vaschette temperatura ambiente

Cold store +2/+4°C  
Refrigerated trays for sauces and fruit +2/+4°C  
Heated trays for hot sources +40/+60°C  
Trays at room temperature

**TOPPING NEUTRO**  
Neutral Topping

**TOPPING FRIGO JUNIOR**  
Junior Frigo Topping

**TOPPING FRIGO CALDO E NEUTRO**  
Frigo, Hot and Neutral Topping

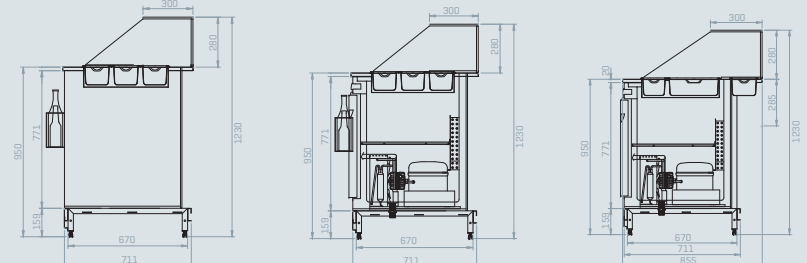



# SMOOTH MINIMALE E DUTTILE

*Smooth. Minimal and ductile.*



#### Piano di servizio

Modulari, interamente realizzati in acciaio inox con rivestimento isolato per garantire massima funzionalità.

#### Top work

Modular, completely in S/s with isolating coating to give top degree functionality.

#### Struttura base

Realizzata in acciaio Inox AISI 304, con isolamento realizzato grazie al poliuretano espanso ecologico con una densità di 40Kg/m<sup>3</sup>.

#### Supporting structure

Completely in AISI 304 S/s, realized by using eco-label polyurethane foam with 40Kg/m<sup>3</sup> density.

#### Vetro

Elevate prestazioni grazie al doppio vetro termico, alla cornice in acciaio Inox AISI 304 ed alle guarnizioni termoplastiche.

#### Glazing materials

Top degree performance thanks to double thermic glass, to AISI 304 S/s frame and to thermoplastic seal.

#### Impianto refrigerante

Con evaporatore ventilato, unità condensatrice ermetica condensata ad aria [o ad acqua optional] unità interna a capillare, unità esterna con impianto a valvola.

#### Refrigeration system

With ventilated evaporator, internal air-cooled hermetic condensing unit [water-cooled optional] and capillary system, remote condensing unit with valve system

# SMOOTH Gelateria ventilata

Smooth ventilated gelato display cabinet

H120

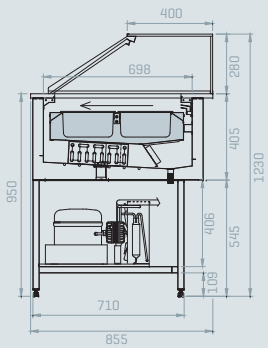

# SMOOTH TN ventilata

Smooth ventilated TN display cabinet

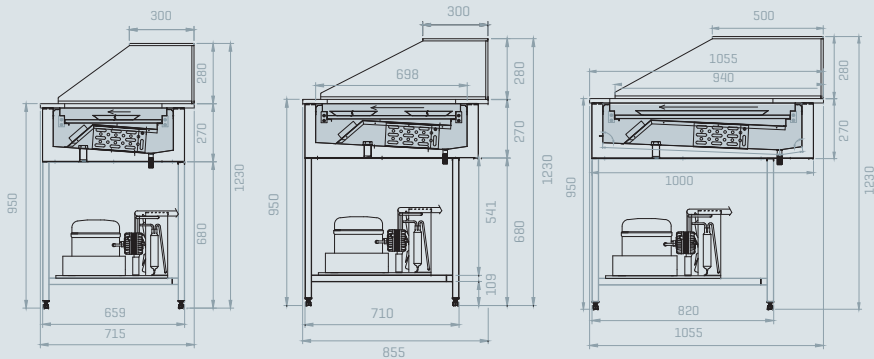

# SMOOTH TN ventilata / Riserva

Smooth static refrigeration TN display cabinet

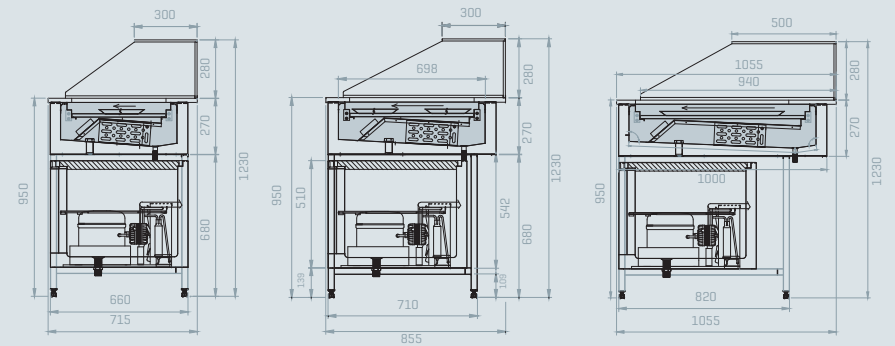

# SMOOTH Refrigerazione Statica

Smooth static refrigeration TN display cabinet

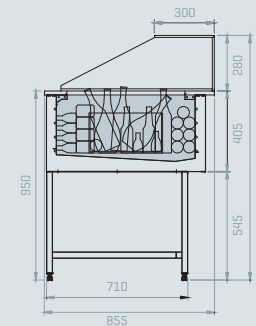

SERIE  
SMOOTH  
Smooth Series



# SMOOTH Calda a secco

Smooth Eat

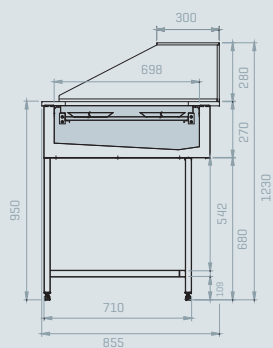

# SMOOTH Bagno maria

Smooth Bain-Marie

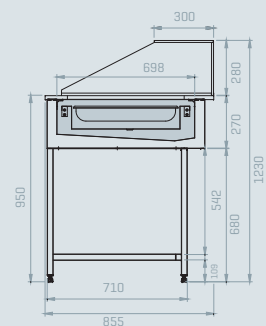

# SMOOTH dati tecnici

Technical details

MOD.	TEMPERATURA ESERCIZIO (°C) WORKING TEMPERATURE (°C)	RESA FRIGO (Watt) REFRIGERATION POWER OUTPUT (Watt)	ALIMENTAZIONE ELETTRICA V/ph/Hz POWER SUPPLY V/ph/Hz	POTENZA ASSORBITA (Watt) ELECTRICAL POWER OUTPUT (Watt)	PESO NETTO (kg) NET WEIGHT (kg)
SMF UC 100	+2 / +4°C	400	230 /1/50	420	-
SMF UC 125	+2 / +4°C	509	230 /1/50	486	-
SMF UC 150	+2 / +4°C	710	230 /1/50	760	-
SMF UC 200	+2 / +4°C	950	230 /1/50	800	-
SMCS 100	+40 / +60°C	-	230 /1/50	600	-
SMCS 125	+40 / +60°C	-	230 /1/50	600	-
SMCS 150	+40 / +60°C	-	230 /1/50	1200	-
SMCS 200	+40 / +60°C	-	230 /1/50	1800	-

# SMOOTH Gelateria ventilata

Smooth ventilated gelato display cabinet

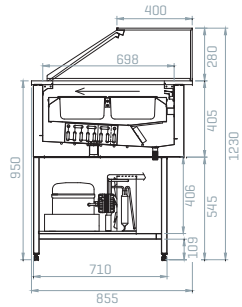

## SMOOTH 100



cod. cod.

SMG100-B

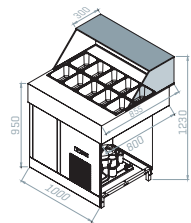

VISTE DALL'ALTO TOP VIEW



## SMOOTH 125



cod. cod.

SMG125-B

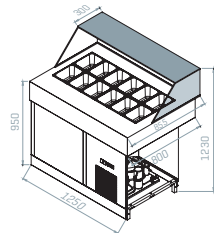

VISTE DALL'ALTO TOP VIEW

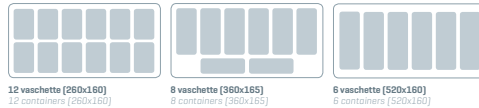

## SMOOTH 150



cod. cod.

SMG150-B

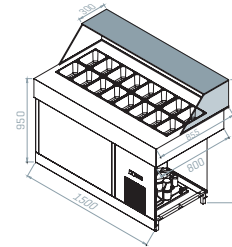

VISTE DALL'ALTO TOP VIEW



## SMOOTH 200



cod. cod.

SMG200-B

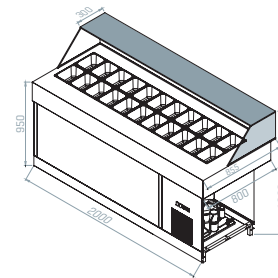

VISTE DALL'ALTO TOP VIEW

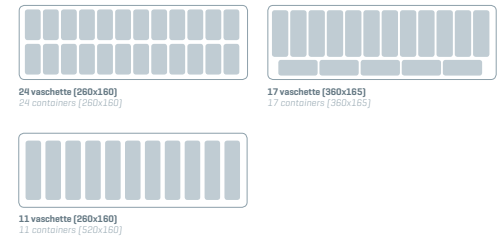

SERIE SMOOTH Smooth Series

# SMOOTH TN ventilata

Smooth ventilated TN display cabinet

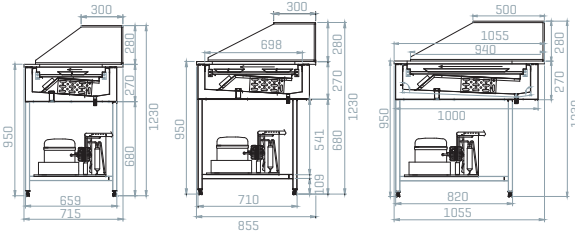

## SMOOTH 100

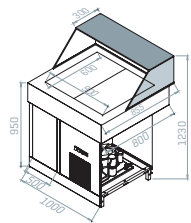

cod. cod.	prof. depth
SMF100-P60-B	600
SMF100-P80-B	800
SMF100-P100-B	1000

## SMOOTH 125

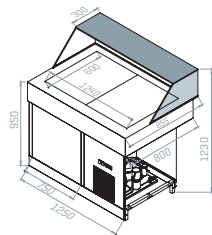

cod. cod.	prof. depth
SMF125-P60-B	600
SMF125-P80-B	800
SMF125-P100-B	1000

## SMOOTH 150

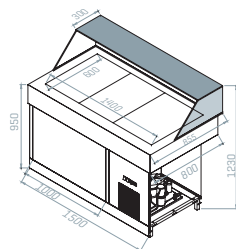

cod. cod.	prof. depth
SMF150-P60-B	600
SMF150-P80-B	800
SMF150-P100-B	1000

## SMOOTH 200

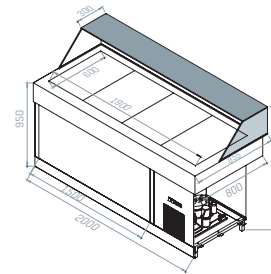

cod. cod.	prof. depth
SMF200-P60-B	600
SMF200-P80-B	800
SMF200-P100-B	1000

## SMOOTH 250

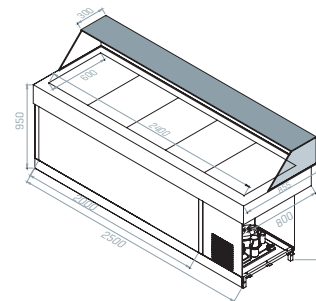

cod. cod.	prof. depth
SMF250-P60-B	600
SMF250-P80-B	800
SMF250-P100-B	1000

## SMOOTH 300

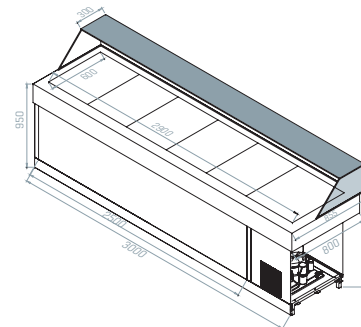

cod. cod.	prof. depth
SMF300-P60-B	600
SMF300-P80-B	800
SMF300-P100-B	1000

SERIE SMOOTH Smooth Series

# SMOOTH TN ventilata / Riserva

Smooth ventilated TN display cabinet with storage

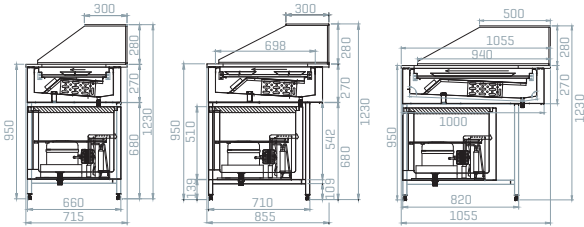

## SMOOTH 150

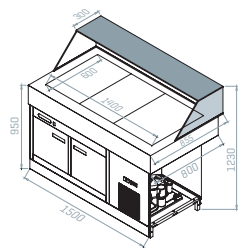

cod. cod.	prof. depth
SMFVR150-P60-B	600
SMFVR150-P80-B	800
SMFVR150-P100-B	1000

## SMOOTH 200

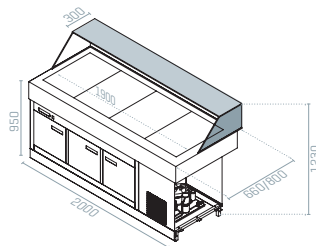

cod. cod.	prof. depth
SMFVR200-P60-B	600
SMFVR200-P80-B	800
SMFVR200-P100-B	1000

## SMOOTH 250

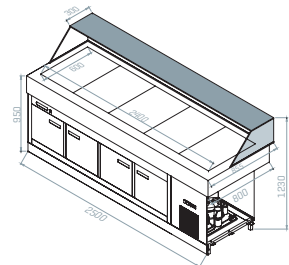

cod. cod.	prof. depth
SMFVR250-P60-B	600
SMFVR250-P80-B	800
SMFVR250-P100-B	1000

# SMOOTH Refrigerazione Statica

Smooth static refrigeration TN display cabinet

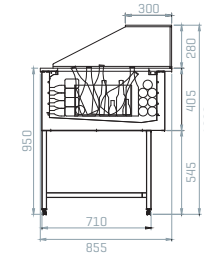

## SMOOTH 100

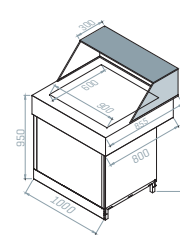

cod. cod.	prof. depth
SMFS100-P80-B	800

## SMOOTH 125

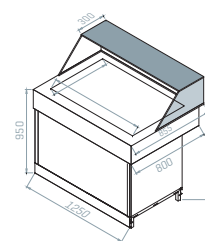

cod. cod.	prof. depth
SMFS125-P80-B	800

## SMOOTH 150

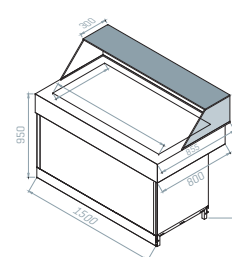

cod. cod.	prof. depth
SMFS150-P80-B	800

SERIE SMOOTH Smooth Series



# SMOOTH Calda a secco

Smooth Eat

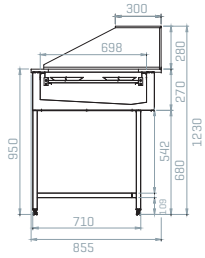

## SMOOTH 100

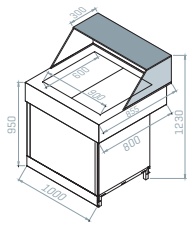

cod. cod. prof. depth

SMCS100-P80-B

800

# SMOOTH Bagno maria

Smooth Bain-Marie

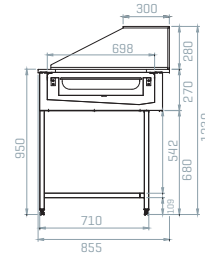

## SMOOTH 100

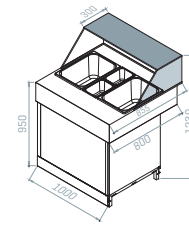

cod. cod. prof. depth

SMCB100-P80-B

800

## SMOOTH 125

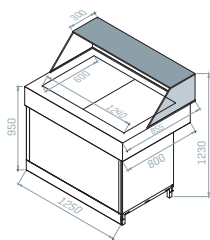

cod. cod. prof. depth

SMCS125-P80-B

800

## SMOOTH 125

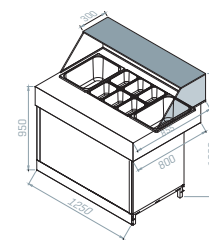

cod. cod. prof. depth

SMCB125-P80-B

800

## SMOOTH 150

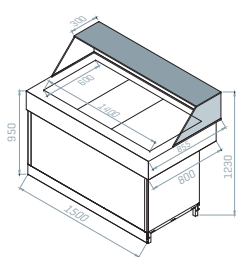

cod. cod. prof. depth

SMCS150-P80-B

800

## SMOOTH 150

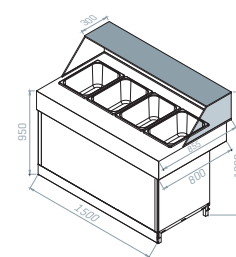

cod. cod. prof. depth

SMCB150-P80-B

800

# SMOOTH Banco servizio Neutro

Smooth ambient service counter

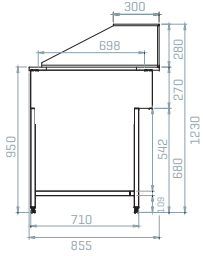

## SMOOTH 100

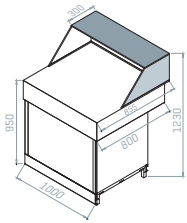

cod. cod.	prof. depth
SMN100-P80-B	800

## SMOOTH 125

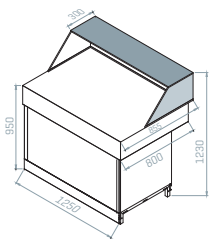

cod. cod.	prof. depth
SMN125-P80-B	800

## SMOOTH 150

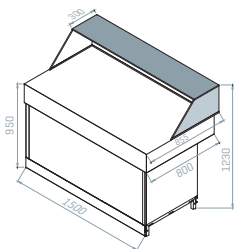

cod. cod.	prof. depth
SMN150-P80-B	800

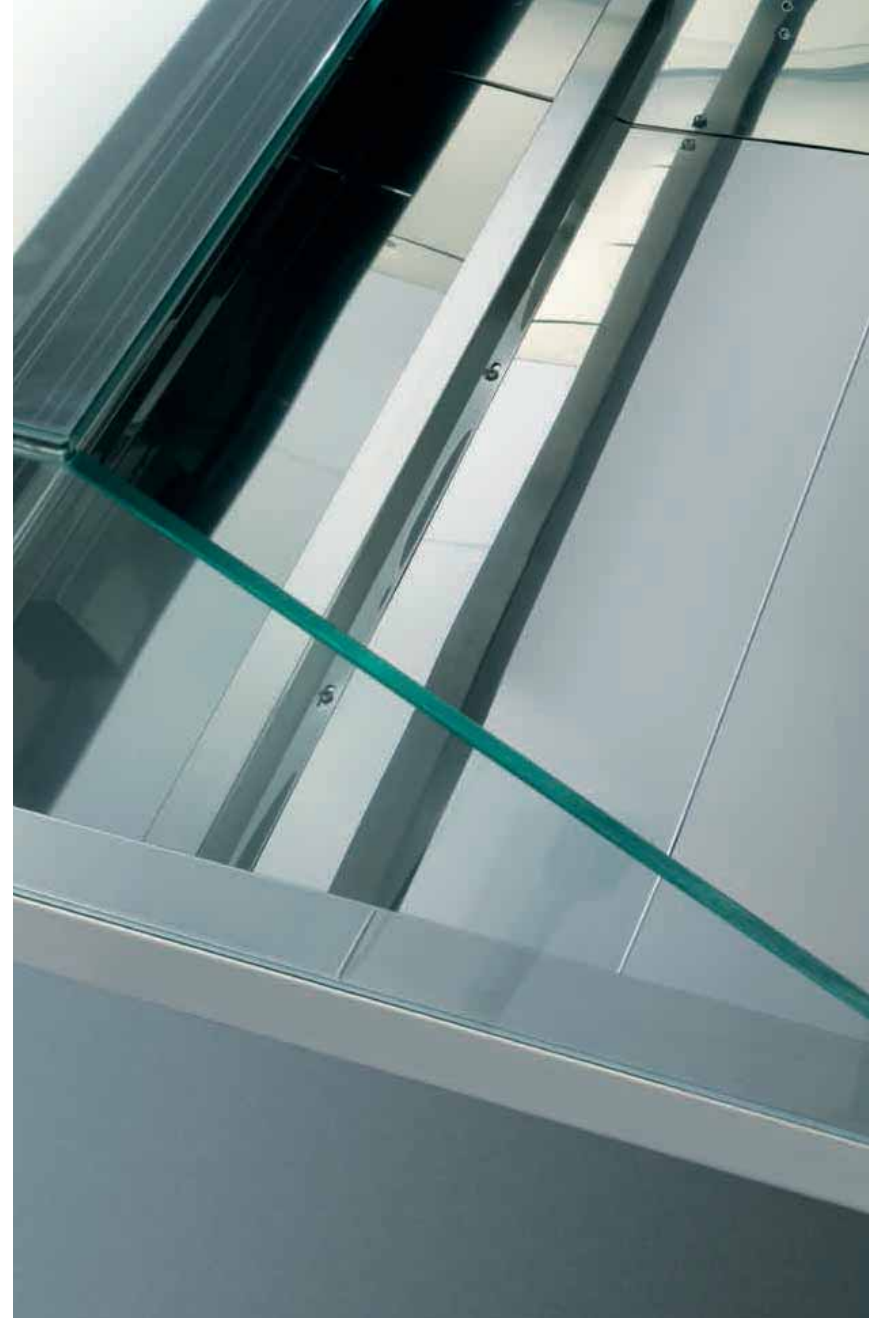

# SMOOTH Drop in

Smooth Drop in with connected unit

CON UNITÀ COLLEGATA

 **VENTILATA** VENTILATED

Smooth vasca TN ventilata, schiumata interamente in acciaio inox.  
Completa di vassoio in inox e quadretto comandi.

Smooth ventilated TN container, foamed and completely in S/s.  
S/s tray and control panel included.

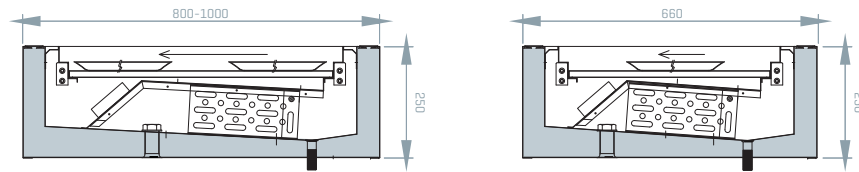

## SMOOTH SR 1500 Smooth SR 1500

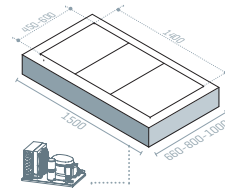

 **VENTILATA**  
VENTILATED

 **VENTILATA**  
VENTILATED

 **VENTILATA**  
VENTILATED

cod. cod.	prof. depth
SMFUC150-60	660
SMFUC150-80	800
SMFUC150-100	1000

## SMOOTH SR 2000 Smooth SR 2000

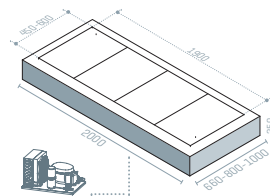

 **VENTILATA**  
VENTILATED

 **VENTILATA**  
VENTILATED

 **VENTILATA**  
VENTILATED

cod. cod.	prof. depth
SMFUC200-60	660
SMFUC200-80	800
SMFUC200-100	1000

## SMOOTH SR 2500 Smooth SR 2500

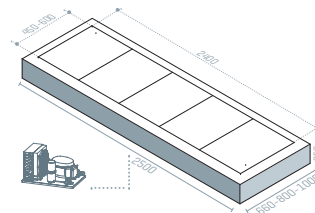

 **VENTILATA**  
VENTILATED

 **VENTILATA**  
VENTILATED

 **VENTILATA**  
VENTILATED

cod. cod.	prof. depth
SMFUC250-60	660
SMFUC250-80	800
SMFUC250-100	1000

## SMOOTH SR 3000 Smooth SR 3000

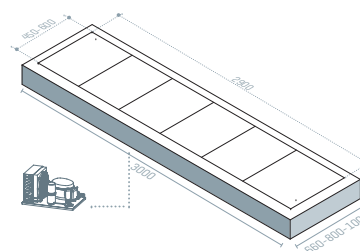

 **VENTILATA**  
VENTILATED

 **VENTILATA**  
VENTILATED

 **VENTILATA**  
VENTILATED

cod. cod.	prof. depth
SMFUC300-60	660
SMFUC300-80	800
SMFUC300-100	1000

## SMOOTH SR 1000 Smooth SR 1000

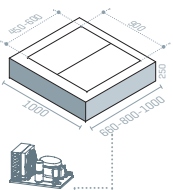

 **VENTILATA**  
VENTILATED

 **VENTILATA**  
VENTILATED

 **VENTILATA**  
VENTILATED

cod. cod.	prof. depth
SMFUC100-60	660
SMFUC100-80	800
SMFUC100-100	1000

## SMOOTH SR 1250 Smooth SR 1250

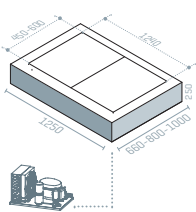

 **VENTILATA**  
VENTILATED

 **VENTILATA**  
VENTILATED

 **VENTILATA**  
VENTILATED

cod. cod.	prof. depth
SMFUC125-60	660
SMFUC125-80	800
SMFUC125-100	1000

SERIE SMOOTH Smooth Series

# SMOOTH Drop in

Smooth Drop in without C.U.

SENZA U.C.



Smooth vasca TN ventilata, schiumata interamente in acciaio inox.  
Completa di vassoio in inox e quadretto comandi.

Smooth ventilated TN container, foamed and completely in S/s.  
S/s tray and control panel included.

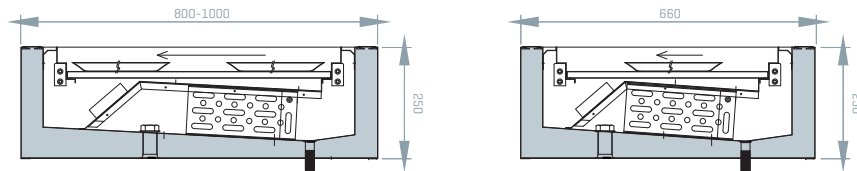

## SMOOTH R 1000 Smooth SR 1000

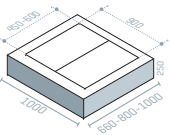

cod. cod.	prof. depth	
SMF100-60	660	
SMF100-80	800	
SMF100-100	1000	

## SMOOTH R 1250 Smooth SR 1250

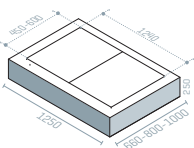

cod. cod.	prof. depth	
SMF125-60	660	
SMF125-80	800	
SMF125-100	1000	

## SMOOTH R 1500 Smooth SR 1500

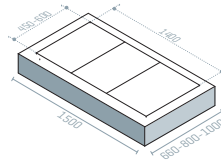

cod. cod.	prof. depth	
SMF150-60	660	
SMF150-80	800	
SMF150-100	1000	

## SMOOTH R 2000 Smooth SR 2000

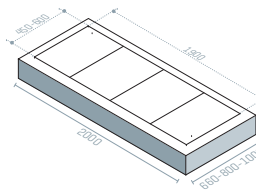

cod. cod.	prof. depth	
SMF200-60	660	
SMF200-80	800	
SMF200-100	1000	

## SMOOTH R 2500 Smooth SR 2500

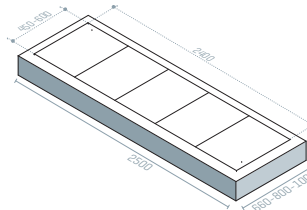

cod. cod.	prof. depth	
SMF250-60	660	
SMF250-80	800	
SMF250-100	1000	

## SMOOTH R 3000 Smooth SR 3000

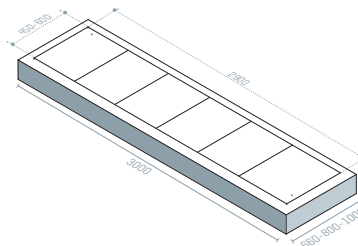

cod. cod.	prof. depth	
SMF300-60	660	
SMF300-80	800	
SMF300-100	1000	



# SMOOTH Drop in

Smooth Drop in heat

CALDA A SECCO

Smooth vasca schiumata interamente in acciaio inox.  
Completa di vassoio in inox.  
Caldo tramite resistenze e quadretto comandi.

Smooth foamed S/s container.  
S/s tray included.  
Electric heater and control panel

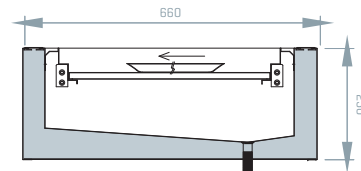
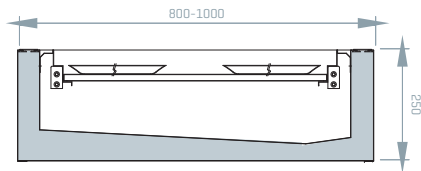

## SMOOTH CS 1000 Smooth SR 1000

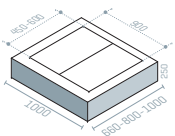

cod. cod.	prof. depth	
SMCS100-60	660	
SMCS100-80	800	
SMCS100-100	1000	

## SMOOTH CS 1250 Smooth SR 1250

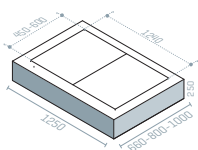

cod. cod.	prof. depth	
SMCS125-60	660	
SMCS125-80	800	
SMCS125-100	1000	

## SMOOTH CS 1500 Smooth SR 1500

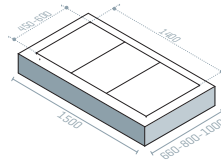

cod. cod.	prof. depth	
SMCS150-60	660	
SMCS150-80	800	
SMCS150-100	1000	

## SMOOTH CS 2000 Smooth SR 2000

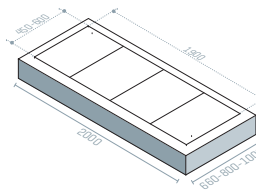

cod. cod.	prof. depth	
SMCS200-60	660	
SMCS200-80	800	
SMCS200-100	1000	

## SMOOTH CS 2500 Smooth SR 2500

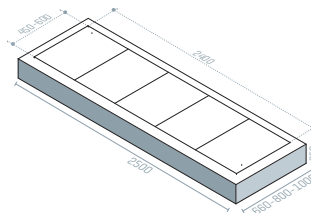

cod. cod.	prof. depth	
SMCS250-60	660	
SMCS250-80	800	
SMCS250-100	1000	

## SMOOTH CS 3000 Smooth SR 3000

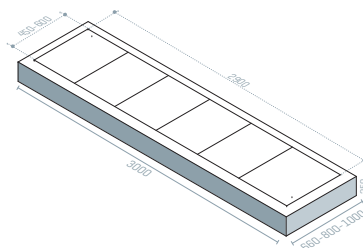

cod. cod.	prof. depth	
SMCS300-60	660	
SMCS300-80	800	
SMCS300-100	1000	

# SMOOTH Drop in

Smooth Drop in Bain-Marie

## BAGNO MARIA

Smooth vasca schiumata interamente in acciaio inox.  
Completa di vassoi in inox forati.  
Caldo tramite resistenze con carico e scarico acqua  
e quadretto comandi.

Smooth foamed container completely in S/s.  
S/s perforated tray included.  
Electric heater with inlet/by pass water valve and panel control.

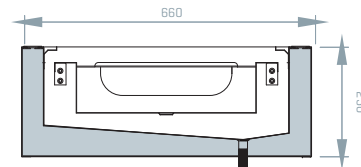
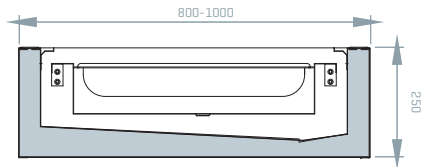

## SMOOTH BM 1000 *Smooth TN-BM 1000*

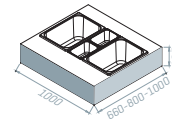

cod. cod.	prof. depth	
SMCBS100-60	660	
SMCBS100-80	800	
SMCB100-100	1000	

## SMOOTH BM 1250 *Smooth TN-BM 1250*

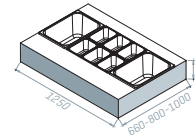

cod. cod.	prof. depth	
SMCBS125-60	660	
SMCBS125-80	800	
SMCB125-100	1000	

## SMOOTH BM 1500 *Smooth TN-BM 1500*

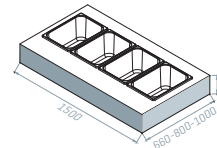

cod. cod.	prof. depth	
SMCBS150-60	660	
SMCBS150-80	800	
SMCB150-100	1000	

## SMOOTH BM 2000 *Smooth TN-BM 2000*

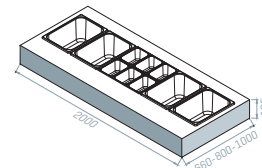

cod. cod.	prof. depth	
SMCBS200-60	660	
SMCBS200-80	800	
SMCB200-100	1000	

# SMOOTH Drop in

Smooth Drop in Gelato display with connected C.U. without structure



Smooth vasca gelato.

Struttura completamente in acciaio inox AISI 304.

Sbrinamento dell'evaporatore veloce ad inversione di ciclo.

Unità condensatrice ermetica 230V/50.

Vetrina utilizzabile anche per semifreddi, torte gelato,

stecchi e monoporzione.

Smooth gelato tray.

S/s AISI 304 structure.

Reverse cycle evaporator defrosting.

230V/50 Ermetic condensator unit.

Display can be used for semifreddos, gelato cakes, steccos and single dose.

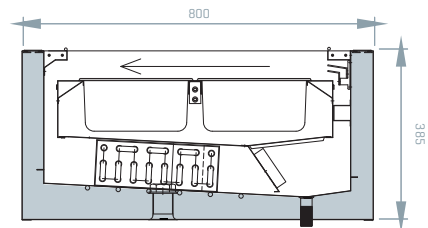

## SMOOTH GELATO 1000 *Smooth Gelato 1000*



cod. cod. prof. depth

SMG100 800

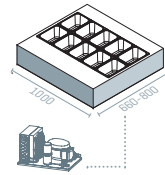

## SMOOTH GELATO 1250 *Smooth Gelato 1250*



cod. cod. prof. depth

SMG125 800

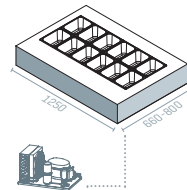

## SMOOTH GELATO 1500 *Smooth Gelato 1500*



cod. cod. prof. depth

SMG150 800

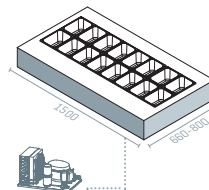

## SMOOTH GELATO 2000 *Smooth Gelato 2000*



cod. cod. prof. depth

SMG200 800

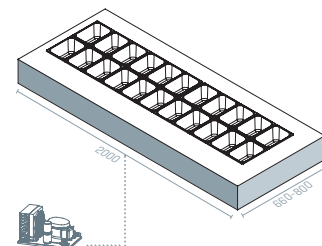

# SMOOTH Drop in

Smooth Drop in Bar with connected U.C. without structure

BAR CON U.C. COLLEGATA SENZA STRUTTURA



Smooth vasca bottiglie.  
Struttura completamente in acciaio inox AISI 304.  
Unità condensatrice ermetica 230V/50.  
refrigerazione statica.

Smooth bottle container.  
AISI 304 S/s structure.  
230V/50 Ermetic condensator unit.  
Static refrigeration.

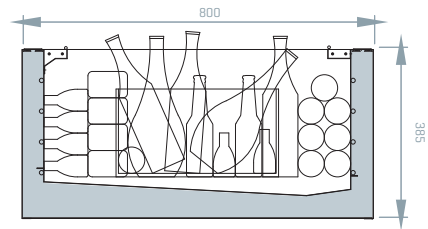

## SMOOTH BAR 1000 *Smooth Bar 1000*



cod. cod. prof. depth

SMFS100	660	
---------	-----	--

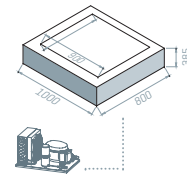

## SMOOTH BAR 1250 *Smooth Bar 1250*



cod. cod. prof. depth

SMFS125	660	
---------	-----	--

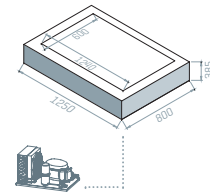

## SMOOTH BAR 1500 *Smooth Bar 1500*



cod. cod. prof. depth

SMFS150	660	
---------	-----	--

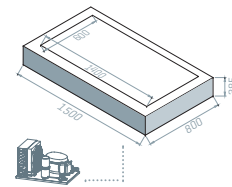

## SMOOTH BAR 2000 *Smooth Bar 2000*



cod. cod. prof. depth

SMFS200	660	
---------	-----	--

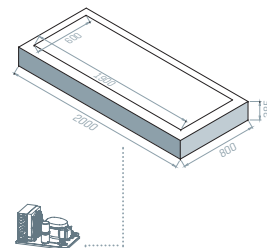

SERIE  
SMOOTH  
Smooth Series



# SMOOTH Optionals

## VASCHE GELATO

S/S Containers

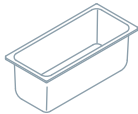

cod. cod.	modello model	
VSC08/P170	260x160	
VSC09/P110	520x160	
VSC09/P150	520x160	

## SEPARATORE OLIO

Oil separator



cod. cod.	
SOL	

## KIT RUOTE

Castors kit

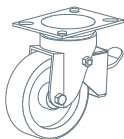

cod. cod.	
RUOTE	

## LAVAPORZIONATORE

Scoop washer

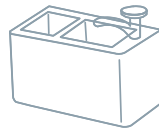

cod. cod.	modello model	
LVCS	Console standata <i>curved console</i>	
LVC	Console standard <i>standard console</i>	

## PREDISPOSIZIONE UNITÀ ESTERNA

Remote condensing unit preparation

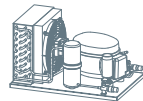

cod. cod.	modello model	
PUEE	Ermetico <i>Hermetic cond. unit</i>	
PUES	Semiermetico <i>Semi-hermetic cond. unit</i>	

## SUPPLEMENTO TEMP. POSITIVA

Extra cost for positive temperature



cod. cod.	
STPS	

## MAGGIORAZIONE CONDENSAZIONI U.C.

Condensing unit

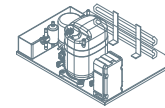

cod. cod.	modello model	
C-AQ	Ad acqua <i>water cooled</i>	
C-AR/AQ	Mista aria-acqua <i>air/water cooled</i>	
CTR	Cond. tropicalizzato per u.c. remota <i>Tropicalised</i>	

## PIANI INOX

S/S Trays

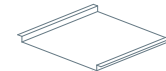

cod. cod.	
VSX100	
VSX125	
VSX150	
VSX200	
VSX250	
VSX300	

## 60 HZ

60 Hz

# 60Hz

cod. cod.	
UC60HZ	

## MENSOLA SUPPLEMENTARE

Extra shelf

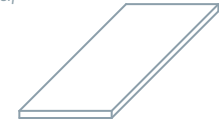

cod. cod.	
MI-100	
MI-125	
MI-150	
MI-200	
MI-250	
MI-300	

## PIANO CALDO ESPOSIZIONE

Warm display top

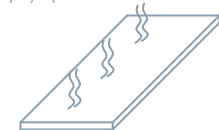

cod. cod.	
PCE-100	
PCE-125	
PCE-150	
PCE-200	
PCE-250	
PCE-300	

# SMOOTH Optionals

## TASCA PORTACARTA

Bag holder

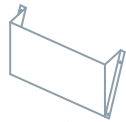

cod. cod.

TPCT

## RULLO PORTACARTA

Paper roll holder

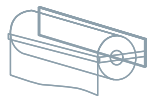

cod. cod.

RPC

## PREDISPOSIZIONE UNITÀ ESTERNA

Remote condensing unit preparation

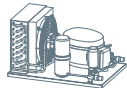

cod. cod.

PUEE

## MAGGIORAZIONE IMPIANTO REFRIGERAZIONE PER PRALINERIA CON CONTROLLO DI UMIDITÀ

Supplement for pralinery refrigeration system with humidity control

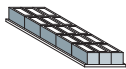

cod. cod.

MAGG-PRA

## VASCHETTA GASTRONOMIA

Gastro norm Containers

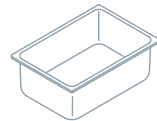

cod. cod.	modello model	
VG1/1-H100	530x325	
VG1/2-H100	325x265	
VG1/3-H100	325x177	
VG1/4-H100	265x162	
VG1/6-H100	177x162	
VG1/9-H100	177x108	
VG2/3-H100	350x325	
VG1/1-H65	530x325	
VG1/2-H65	325x265	
VG1/3-H65	325x177	
VG1/4-H65	265x162	
VG1/6-H65	177x162	
VG1/9-H65	177x108	
VG2/3-H65	350x325	

## MAGGIORAZIONE CONDENSAZIONI U.C.

Supplement C.U. Condensation

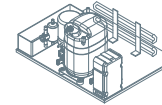

cod. cod.

modello model

URCAQ	Ad acqua water cooled	
URCAR/AQ	Mista aria-acqua air/water cooled	

## COPERCHI GASTRONOMIA

Gastro norm lid

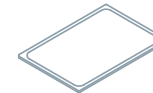

cod. cod.

CR1/1	
CR1/2	
CR1/3	
CR1/4	
CR1/6	
CR1/9	
CR2/3	

## MAGGIORAZIONE VANO ESPOSITIVO VERNICIATO COLORE NERO

Supplement for black painted display box

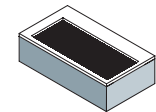

cod. cod.

MVEN 100	
MVEN 125	
MVEN 150	
MVEN 200	
MVEN 250	
MVEN 300	

## AGGIUNTA VETRO EXTRACHIARO PER TECA

Supplement for extra-clear glass display

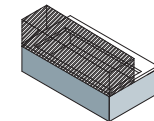

cod. cod.

TECA 100 EX	
TECA 125 EX	
TECA 150 EX	
TECA 200 EX	
TECA 250 EX	
TECA 300 EX	

# SMOOTH Optionals

## CARTER DI CHIUSURA PER ZOCHE LATO INFERIORE OPERATORE

Closing carter to protect the lower part of the service side

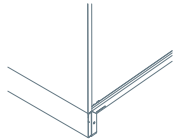

cod. cod.

ZOCC [al ml]

## COPPIA COLONNINI REGGI CRISTALLO

Pair of glass shelf support brackets

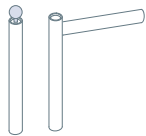

cod. cod.

CORD

CORA

## PALLET IN LEGNO

Wooden pallet

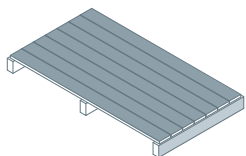

cod. cod.

PALLET

## INSERIMENTO SCORRIVASSOIO IN ACCIAIO INOX

S/s slide tray insertion

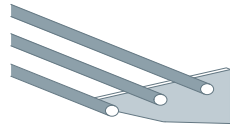

cod. cod.

SCOR [al ml]

## ILLUMINAZIONE LED FRONTALE

Frontal LED Lights system



cod. cod.

LED-F

## ILLUMINAZIONE LED CON PLAFONIERA

Led Dome lights



cod. cod.

LED100

LED125

LED150

LED200

LED250

LED300

## PIANO DI SERVIZIO IN GRANITO

Granite topwork configuration

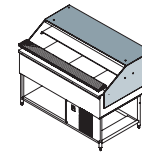

cod. cod.

PSG

## INSERIMENTO PIANO INOX PORTA BILANCIA

S/s countertop scale-holder addition

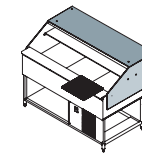

cod. cod.

PIPB

## CASSA IN LEGNO PER TRASPORTO

Wooden boxes for transporting

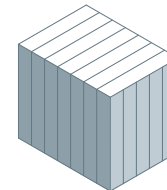

cod. cod.

BOX

## PIANO PERIMETRALE PER SMOOTH IN GRANITO/CORIAN

Granite/corain perimeter for SMOOTH

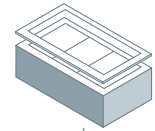

cod. cod.

PER 100

PER 125

PER 150

PER 200

PER 250

PER300

## SCORREVOLI IN PLEXIGLASS

Sliding plexiglass doors



cod. cod.

PER 100

PER 125

PER 150

PER 200

PER 250

PER 300

SERIE SMOOTH Smooth Series

# COLORIS PERSONALISABLES

Toutes les vitrines sont conçues pour satisfaire vos besoins, même en couleurs.  
Vous pouvez choisir et personnaliser votre vitrine selon votre goût et la décoration de votre lieu.

