

# LIGNE NEUTRE

**Compléments de  
cuisine professionnelle**

## Ligne Neutre UNI – GN1/1

- \* Matériel utilisé: acier inox Aisi 304.
- \* Profondeur du meuble: 625mm, avec la possibilité d'ajouter des bacs GN1/1
- \* Plans de travail: hauteur 50 mm. avec bord plié à 90°. Ils sont proposés en 2 profondeurs: · 630mm · 700mm, insonorisé avec panneaux bilaminés.
- \* Dossieret: hauteur 100 mm., il est d'une seule pièce avec le plan de travail et renforcé.
- \* Portes: renforcées soit battantes soit coulissantes; poignées ergonomiques en une seule pièce.
- \* Tiroirs: frontal renforcé; poignée ergonomique en une seule pièce; glissières télescopiques à extraction totale en acier zingué, bacs GN1/1 en polyéthylène atoxique.
- \* Rechauffage armoire: ventilé avec convoyeur; réglage thermostatique de la température.
- \* Pieds: en tubes carrés 40x40mm avec pied niveleur en acier inox Aisi 304.
- \* Emballage: palette + carton à trois épaisseurs



N.B.1: les tables sur pieds sont expédiées démontées.

N.B.2: les tiroirs peuvent être seulement installés sur des tables avec pied et étagère.



**Gamme  
Compléments  
de cuisine professionnelle**

# Neutre UNI - GN1/1 Placard mural ouvert





| mod.  | mm.           |  |  |
|-------|---------------|---|---|
| PI45A | 450x400x650H  | 17  | 0,10  |
| PI9A  | 900x400x650H  | 18  | 0,18  |
| PI10A | 1000x400x650H | 19  | 0,20  |
| PI12A | 1200x400x650H | 22  | 0,25  |
| PI13A | 1300x400x650H | 23  | 0,27  |
| PI14A | 1400x400x650H | 25  | 0,29  |
| PI15A | 1500x400x650H | 26  | 0,31  |
| PI16A | 1600x400x650H | 27  | 0,34  |
| PI17A | 1700x400x650H | 28  | 0,36  |
| PI18A | 1800x400x650H | 30  | 0,38  |
| PI19A | 1900x400x650H | 32  | 0,40  |
| PI20A | 2000x400x650H | 34  | 0,42  |
| PI21A | 2100x400x650H | 36  | 0,44  |

Avec fond et étagère



| mod.  | mm.           |  |  |
|-------|---------------|---|---|
| PG45A | 450x400x650H  | 17  | 0,10  |
| PG9A  | 900x400x650H  | 18  | 0,18  |
| PG10A | 1000x400x650H | 19  | 0,20  |
| PG12A | 1200x400x650H | 22  | 0,25  |
| PG13A | 1300x400x650H | 23  | 0,27  |
| PG14A | 1400x400x650H | 25  | 0,29  |
| PG15A | 1500x400x650H | 26  | 0,31  |
| PG16A | 1600x400x650H | 27  | 0,34  |
| PG17A | 1700x400x650H | 28  | 0,36  |
| PG18A | 1800x400x650H | 30  | 0,38  |
| PG19A | 1900x400x650H | 32  | 0,40  |
| PG20A | 2000x400x650H | 34  | 0,42  |
| PG21A | 2100x400x650H | 36  | 0,44  |

Avec fond et étagère perforés



| mod.    | mm.            |  |  |
|---------|----------------|---|---|
| PI12A10 | 1200x400x1000H | 27  | 0,34  |
| PI13A10 | 1300x400x1000H | 28  | 0,36  |
| PI14A10 | 1400x400x1000H | 30  | 0,38  |
| PI15A10 | 1500x400x1000H | 32  | 0,40  |
| PI16A10 | 1600x400x1000H | 34  | 0,42  |



Avec fond et étagère

| mod.    | mm.            |  |  |
|---------|----------------|---|---|
| PG12A10 | 1200x400x1000H | 27  | 0,34  |
| PG13A10 | 1300x400x1000H | 28  | 0,36  |
| PG14A10 | 1400x400x1000H | 30  | 0,38  |
| PG15A10 | 1500x400x1000H | 32  | 0,40  |
| PG16A10 | 1600x400x1000H | 34  | 0,42  |

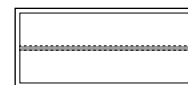

Avec fond et étagère perforés

# Neutre UNI - GN1/1 Armoires suspendues portes coulissantes





| mod.  | mm.           |  |  |
|-------|---------------|---|---|
| PI10C | 1000x400x650H | 23  | 0,25  |
| PI12C | 1200x400x650H | 27  | 0,27  |
| PI13C | 1300x400x650H | 29  | 0,29  |
| PI14C | 1400x400x650H | 32  | 0,31  |
| PI15C | 1500x400x650H | 34  | 0,34  |
| PI16C | 1600x400x650H | 36  | 0,36  |
| PI17C | 1700x400x650H | 38  | 0,38  |
| PI18C | 1800x400x650H | 41  | 0,40  |
| PI19C | 1900x400x650H | 44  | 0,42  |
| PI20C | 2000x400x650H | 47  | 0,44  |
| PI21C | 2100x400x650H | 50  | 0,57  |

Avec fond et étagère

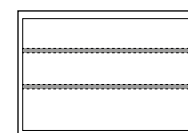

| mod.  | mm.           |  |  |
|-------|---------------|---|---|
| PG10C | 1000x400x650H | 23  | 0,25  |
| PG12C | 1200x400x650H | 27  | 0,27  |
| PG13C | 1300x400x650H | 29  | 0,29  |
| PG14C | 1400x400x650H | 32  | 0,31  |
| PG15C | 1500x400x650H | 34  | 0,34  |
| PG16C | 1600x400x650H | 36  | 0,36  |
| PG17C | 1700x400x650H | 38  | 0,38  |
| PG18C | 1800x400x650H | 41  | 0,40  |
| PG19C | 1900x400x650H | 44  | 0,42  |
| PG20C | 2000x400x650H | 47  | 0,44  |
| PG21C | 2100x400x650H | 50  | 0,57  |

Avec fond et étagère perforés





| mod.    | mm.            |  |  |
|---------|----------------|---|---|
| PI12C10 | 1200x400x1000H | 32  | 0,34  |
| PI13C10 | 1300x400x1000H | 34  | 0,36  |
| PI14C10 | 1400x400x1000H | 37  | 0,38  |
| PI15C10 | 1500x400x1000H | 39  | 0,40  |
| PI16C10 | 1600x400x1000H | 41  | 0,42  |

Avec fond et étagère

| mod.    | mm.            |  |  |
|---------|----------------|---|---|
| PG12C10 | 1200x400x1000H | 32  | 0,34  |
| PG13C10 | 1300x400x1000H | 34  | 0,36  |
| PG14C10 | 1400x400x1000H | 37  | 0,38  |
| PG15C10 | 1500x400x1000H | 39  | 0,40  |
| PG16C10 | 1600x400x1000H | 41  | 0,42  |



Avec fond et étagère perforés

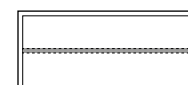

| mod.   | mm.          |  |  |
|--------|--------------|---|---|
| LPI45B | 450x400x650H | 10  | 0,1   |

À portes battantes avec étagère





| mod.  | mm.          |  |  |
|-------|--------------|---|---|
| LPI9B | 900x400x650H | 18  | 0,18  |



À portes battantes avec étagère

# Neutre UNI - GN1/1 Accessoires pour meubles suspendus





| mod.  | mm.          |  |  |
|-------|--------------|---|---|
| RPS45 | 450x330x30H  | 4   | 0,02  |
| RPS9  | 900x330x30H  | 5   | 0,02  |
| RPS10 | 1000x330x30H | 6   | 0,02  |
| RPS12 | 1200x330x30H | 7   | 0,03  |
| RPS13 | 1300x330x30H | 8   | 0,03  |
| RPS14 | 1400x330x30H | 9   | 0,03  |
| RPS15 | 1500x330x30H | 10  | 0,04  |
| RPS16 | 1600x330x30H | 11  | 0,04  |
| RPS17 | 1700x330x30H | 12  | 0,04  |
| RPS18 | 1800x330x30H | 13  | 0,04  |
| RPS19 | 1900x330x30H | 14  | 0,05  |
| RPS20 | 2000x330x30H | 15  | 0,05  |
| RPS21 | 2100x330x30H | 16  | 0,05  |

Étagères

| mod.  | mm.          |  |  |
|-------|--------------|---|---|
| RPG45 | 450x330x30H  | 4   | 0,02  |
| RPG9  | 900x330x30H  | 5   | 0,02  |
| RPG10 | 1000x330x30H | 6   | 0,02  |
| RPG12 | 1200x330x30H | 7   | 0,03  |
| RPG13 | 1300x330x30H | 8   | 0,03  |
| RPG14 | 1400x330x30H | 9   | 0,03  |
| RPG15 | 1500x330x30H | 10  | 0,04  |
| RPG16 | 1600x330x30H | 11  | 0,04  |
| RPG17 | 1700x330x30H | 12  | 0,04  |
| RPG18 | 1800x330x30H | 13  | 0,04  |
| RPG19 | 1900x330x30H | 14  | 0,05  |
| RPG20 | 2000x330x30H | 15  | 0,05  |
| RPG21 | 2100x330x30H | 16  | 0,05  |

Étagères perforées





| mod.  | mm.          |  |  |
|-------|--------------|---|--|
| SPG9  | 860x255x90H  | 5   | 0,02   |
| SPG10 | 960x255x90H  | 6   | 0,02   |
| SPG12 | 1160x255x90H | 7   | 0,03   |
| SPG13 | 1260x255x90H | 8   | 0,03   |
| SPG14 | 1360x255x90H | 9   | 0,03   |
| SPG15 | 1460x255x90H | 10  | 0,04   |
| SPG16 | 1560x255x90H | 11  | 0,04   |
| SPG17 | 1660x255x90H | 12  | 0,04   |
| SPG18 | 1760x255x90H | 13  | 0,04   |
| SPG19 | 1860x255x90H | 14  | 0,05   |
| SPG20 | 1960x255x90H | 15  | 0,05   |
| SPG21 | 2060x255x90H | 16  | 0,05   |

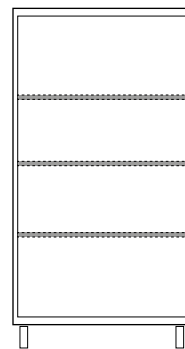
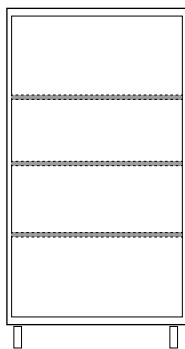

Égouttoir à vaisselle sur plans perforés

# Neutre UNI - GN1/1 Armoires verticales





| mod.  |   | mm.            |  |  |
|-------|---|----------------|---|---|
| AR5B  | 1 | 500x675x1800H  | 52  | 0,8   |
| AR10B | 2 | 1000x675x1800H | 104   | 1,60  |
| AR15B | 3 | 1500x675x1800H | 156   | 2,40  |
| AR20B | 4 | 2000x675x1800H | 171   | 3,20  |

À portes battantes

| mod.  |   | mm.            |  |  |
|-------|---|----------------|---|---|
| AR10C | 2 | 1000x675x1800H | 104   | 1,60  |
| AR13C | 2 | 1300x675x1800H | 130   | 2,00  |
| AR15C | 2 | 1500x675x1800H | 156   | 2,40  |
| AR18C | 2 | 1800x675x1800H | 164   | 2,70  |
| AR20C | 2 | 2000x675x1800H | 171   | 3,20  |

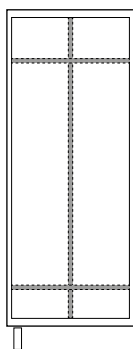
À portes coulissantes





| mod. | mm.                   |  |  |
|------|-----------------------|---|---|
| ASI  | 700x400x1.750/1.900 H | 45  | 0,66  |

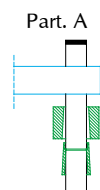

Armoire vestiaire

nr. 2 secteurs indépendants

# Neutre UNI - GN1/1 Rayonnages modulables



| mod.            | mm.            |  |  |
|-----------------|----------------|---|---|
| <b>P400 mm.</b> |                |   |   |
| LSMR4P10-4      | 1000x400x1800H | 22  | 0,13  |
| LSMR4P13-4      | 1300x400x1800H | 30  | 0,16  |
| LSMR4P16-4      | 1600x400x1800H | 34  | 0,18  |
| <b>P500 mm.</b> |                |   |   |
| LSMR4P10-5      | 1000x500x1800H | 26  | 0,15  |
| LSMR4P13-5      | 1300x500x1800H | 34  | 0,2   |
| LSMR4P16-5      | 1600x500x1800H | 38  | 0,24  |
| <b>P700 mm.</b> |                |   |   |
| LSMR4P10-7      | 1000x700x1800H | 30  | ,22   |
| LSMR4P13-7      | 1300x700x1800H | 42  | 0,27  |
| LSMR4P16-7      | 1600x700x1800H | 50  | 0,33  |

| mod.            | mm.          |  |  |
|-----------------|--------------|---|---|
| <b>P400 mm.</b> |              |   |   |
| LRS4-10         | 1000x400x40H | 6   | 0,02  |
| LRS4-13         | 1300x400x40H | 8   | 0,03  |
| LRS4-16         | 1600x400x40H | 11  | 0,04  |
| <b>P500 mm.</b> |              |   |   |
| LRS5-10         | 1000x500x40H | 8   | 0,02  |
| LRS5-13         | 1300x500x40H | 10  | 0,03  |
| LRS5-16         | 1600x500x40H | 13  | 0,04  |
| <b>P700 mm.</b> |              |   |   |
| LRS7-10         | 1000x700x40H | 11  | 0,02  |
| LRS7-13         | 1300x700x40H | 13  | 0,03  |
| LRS7-16         | 1600x700x40H | 16  | 0,04  |

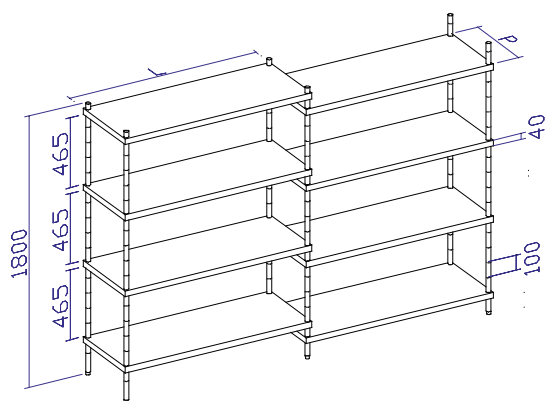

chaque rayonnage dispose de 4 étagères de série

Etagères supplémentaires



Exemple de modularité





| mod.     | mm.        |  |  |
|----------|------------|---|---|
| LMSP2-18 | øx30x1800H | 6   | 0,01  |



nr. 2 montants supplémentaires



# Neutre UNI - GN1/1 Etagères murales





| mod. | mm.                   |  |  |
|------|-----------------------|---|---|
| MMS3 | 1000x <b>300</b> x40H | 4,5   | 0,02  |
| MMS4 | 1000x <b>400</b> x40H | 5,5   | 0,03  |



| mod. | mm.                   |  |  |
|------|-----------------------|---|---|
| MMG3 | 1000x <b>300</b> x40H | 4,5   | 0,02  |
| MMG4 | 1000x <b>400</b> x40H | 5,5   | 0,03  |

Étagères

Étagères perforées



| mod.   | mm.        |  |  |
|--------|------------|---|---|
| CRM-70 | 40x30x700H | 1,70  | 0,02  |
| CRM-35 | 40x30x350H | 0,85  | 0,02  |

| mod.    | mm.        |  |  |
|---------|------------|---|---|
| SMENS-3 | 35x312x70H | 2   | 0,02  |
| SMENS-4 | 35x412x70H | 4   | 0,02  |

Crémaillère

Support

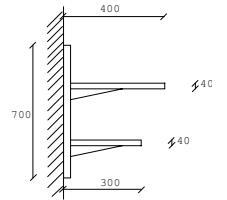
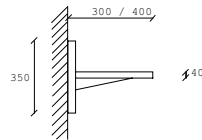

Solution à une étagère:



La longueur maximum autorisée des étagères est de mm 2500.  
2 supports et 2 crémaillères sont nécessaires par mètre courant d'étagère;  
par mètre supplémentaire ou fraction de mètre, il faut ajouter 1 support et 1 crémaillère.

Solution à deux étagères:

4 supports et 2 crémaillères sont nécessaires par mètre courant d'étagère;  
par mètre supplémentaire ou fraction de mètre, il faut ajouter 2 supports et 1 crémaillère.

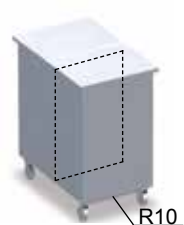



# Neutre UNI - GN1/1 Poubelles / bacs sur charriots



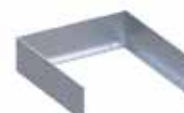

| mod.                                     | mm.          | Lt.   |  |  |
|--|--------------|-------|---|---|
| PCAR-P                                   | ø450x700H    | 100   | 13  | 0,15  |
| PCAR-P-50L                               | ø380x605H    | 50    | 10  | 0,10  |
| <i>Ouverture à pédale</i>                |              |       |   |   |
| PCAR                                     | ø450x740H    | 100   | 12  | 0,15  |
| PCAR-50L                                 | ø380x605H    | 50    | 9   | 0,10  |
| <i>Ouverture manuelle</i>                |              |       |   |   |
| CFZ6-2                                   | 395x700x785H | 73+73 | 21  | 0,34  |
| <i>Avec diviseur - fond arrondi</i>      |              |       |   |   |
| CFZ6                                     | 395x610x785H | 125   | 21  | 0,34  |
| CFZ3                                     | 395x700x785H | 150   | 22  | 0,32  |
| <i>Fond arrondi</i>                      |              |       |   |   |
| VAP580                                   | 600x500x650H |       | 21  | 0,34  |
| VAP680                                   | 800x600x750H |       | 29  | 0,50  |
| <i>Cuves sur roulettes avec decharge</i> |              |       |   |   |

## Billots / Pare-éclats





| mod.               | mm.          |  |  |
|--------------------|--------------|---|---|
| CEP54              | 500x540x900H | 37  | 0,35  |
| CEP70              | 500x700x900H | 46  | 0,43  |
| <i>Billots</i>     |              |   |   |
| mod.               | mm.          |  |  |
| PAR54              | 500x540x150H | 10  | 0,10  |
| PAR70              | 500x700x150H | 14  | 0,14  |
| <i>Pare-Éclats</i> |              |   |   |



| mod.    | mm.          |  |  |  |
|---------|--------------|---|---|---|
| LLMP-35 | 300x315x240H | 100H  | 10  | 0,10  |
| LLMP-50 | 400x400x240H | 150H  | 15  | 0,15  |



Robinet à commande fémorale de l'eau (chaude et froide)



| mod.    | mm.          |  |  |  |
|---------|--------------|---|---|---|
| LLMB-50 | 400x400x800H | 150H  | 30  | 0,22  |



Robinet à commande à pédale de l'eau (chaude et froide)



| mod.   | mm.          |  |  |  |
|--------|--------------|---|---|---|
| LLGV50 | 500x600x850H | 400x400x250H  | 30  | 0,34  |



Robinet à commande manuelle de l'eau (chaude et froide)



| mod. | mm.          |  |  |
|------|--------------|---|---|
| PSC  | 545x150x545H | 4   | 0,044   |



Ensemble porte-papier et savon



| mod. | mm.          |  |  |
|------|--------------|--|--|
| ST-P | 400x135x395H | 7  | 0,06   |

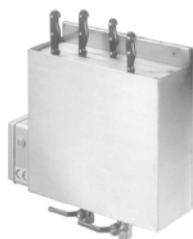

Stérilisateur de couteaux à liquide désinfectant



| mod. | mm.          | V - hZ      | W     |  |  |
|------|--------------|-------------|-------|---|---|
| ST-E | 475x135x465H | 230-1/50/60 | 1.200 | 8   | 0,06  |

Stérilisateur de couteaux électrique





| mod. | mm.          | V - hZ   | W  |  |  |
|------|--------------|----------|----|---|---|
| ST-U | 400x140x760H | 230-1/50 | 70 | 10,5  | 0,06  |

Stérilisateur de couteaux à rayons U.V.A.

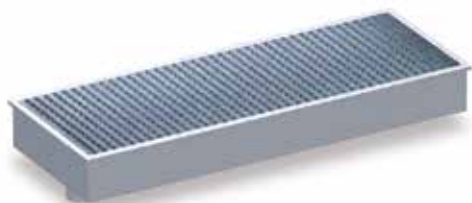
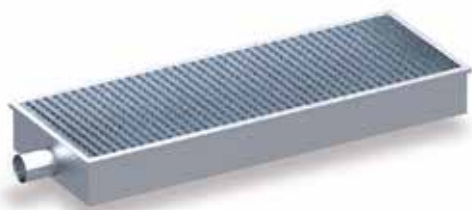
## Sans siphon



| mod.     | mm.            |  |  |
|----------|----------------|---|---|
| GSTL4-O  | 460x460x130H   | 11  | 0,065   |
| GSTL8-O  | 860x460x130H   | 18  | 0,13  |
| GSTL12-O | 1.260x460x130H | 28  | 0,2   |
| GSTL16-O | 1.660x460x130H | 36  | 0,25  |
| GSTL20-O | 2.060x460x130H | 46  | 0,32  |
| GSTL24-O | 2.460x460x130H | 56  | 0,37  |

### Décharge horizontale

|          |                |    |       |
|----------|----------------|----|-------|
| GSTL4-V  | 460x460x130H   | 11 | 0,065 |
| GSTL8-V  | 860x460x130H   | 18 | 0,13  |
| GSTL12-V | 1.260x460x130H | 28 | 0,2   |
| GSTL16-V | 1.660x460x130H | 36 | 0,25  |
| GSTL20-V | 2.060x460x130H | 46 | 0,32  |
| GSTL24-V | 2.460x460x130H | 56 | 0,37  |

### Décharge verticale

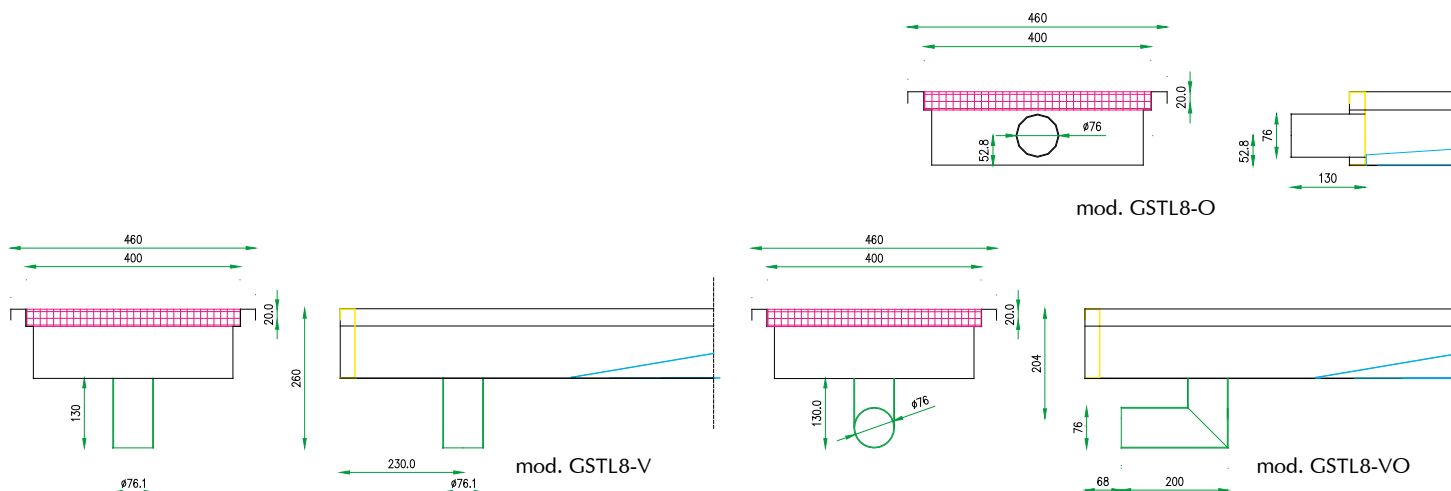

|           |                |    |       |
|-----------|----------------|----|-------|
| GSTL4-VO  | 460x460x130H   | 11 | 0,065 |
| GSTL8-VO  | 860x460x130H   | 18 | 0,13  |
| GSTL12-VO | 1.260x460x130H | 28 | 0,2   |
| GSTL16-VO | 1.660x460x130H | 36 | 0,25  |
| GSTL20-VO | 2.060x460x130H | 46 | 0,32  |
| GSTL24-VO | 2.460x460x130H | 56 | 0,37  |

### Décharge horizontale surbaissée

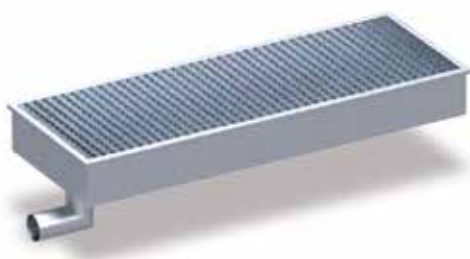

## Avec siphon



| mod.      | mm.            |  |  |
|-----------|----------------|---|---|
| GSTL4-VS  | 460x460x130H   | 11  | 0,065   |
| GSTL8-VS  | 860x460x130H   | 18  | 0,13  |
| GSTL12-VS | 1.260x460x130H | 28  | 0,2   |
| GSTL16-VS | 1.660x460x130H | 36  | 0,25  |
| GSTL20-VS | 2.060x460x130H | 46  | 0,32  |
| GSTL24-VS | 2.460x460x130H | 56  | 0,37  |

### Décharge verticale

|            |                |    |       |
|------------|----------------|----|-------|
| GSTL4-VOS  | 460x460x130H   | 11 | 0,065 |
| GSTL8-VOS  | 860x460x130H   | 18 | 0,13  |
| GSTL12-VOS | 1.260x460x130H | 28 | 0,2   |
| GSTL16-VOS | 1.660x460x130H | 36 | 0,25  |
| GSTL20-VOS | 2.060x460x130H | 46 | 0,32  |
| GSTL24-VOS | 2.460x460x130H | 56 | 0,37  |

### Décharge horizontale surbaissée

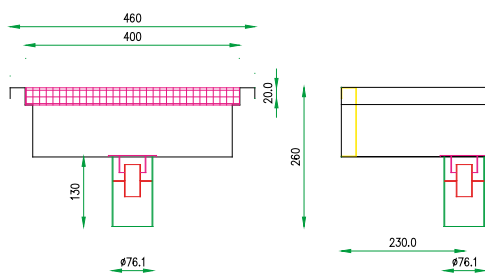

mod. GSTL8-VS

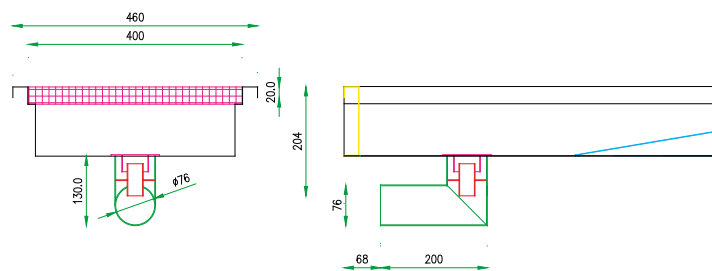

mod. GSTL8-VOS